

HIOKI

DIGITAL MULTIMETER DT4200 Series



NEW
DT4261



Excludes DT4281 and DT4282

DT 4200 SERIES

MADE IN JAPAN



Newly released "DT4261" for wireless communication and DC high voltage measurement!

NEW
DT4261

Bluetooth® wireless technology support for recording and managing measurement data



Now joined by the DT4261!

Bluetooth® communication with Z3210 attached to DT4261 Bluetooth®

Install the Wireless Adapter Z3210 to the DT4261 to enable Bluetooth® communications. With the Z3210, you can transfer data directly to an Excel® file or pair the instrument with GENNECT Cross.



Attach to enable Bluetooth® wireless technology



Ref. value	Measurement	Value (MVA)
R-6	0.0	0.000
R-5	0.0	0.000
R-4	0.0	0.000
R-3	0.0	0.000
R-2	0.0	0.000
R-1	0.0	0.000
R-0	0.0	0.000

Transport to the Excel® file



Transport to GENNECT Cross

Z3210
For more details



Manage measurement data using GENNECT Cross

Pair the DT4261 built in with Bluetooth® wireless technology with the free GENNECT Cross mobile app to further data management, processing and report exporting on your mobile device.

GENNECT
Cross
For more details



Transfer data to a tablet wirelessly



Take a picture of the test location and map measured values on it



View and verify waveforms on your mobile device like on an oscilloscope



Troubleshoot with simple harmonic analysis in the field

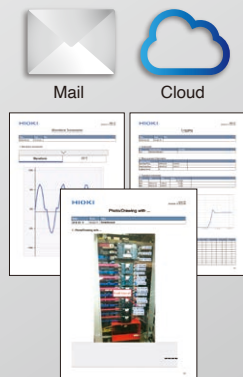

- Save data and create reports right on the App
- Share data via cloud services or E-mail

Measurement up to CAT III 2000 V with the DC High Voltage Probe P2000 in Combination with DT4261

Safe Inspection of Solar Installations with High Voltage

Photovoltaic power generation equipment are becoming increasingly high-voltage in order to reduce costs and improve the efficiency of power generation systems. As a result, it is important to select measuring instruments that support higher voltage measurement to protect the safety of inspection workers.

NEW

DC HIGH VOLTAGE PROBE P2000 *Sold separately

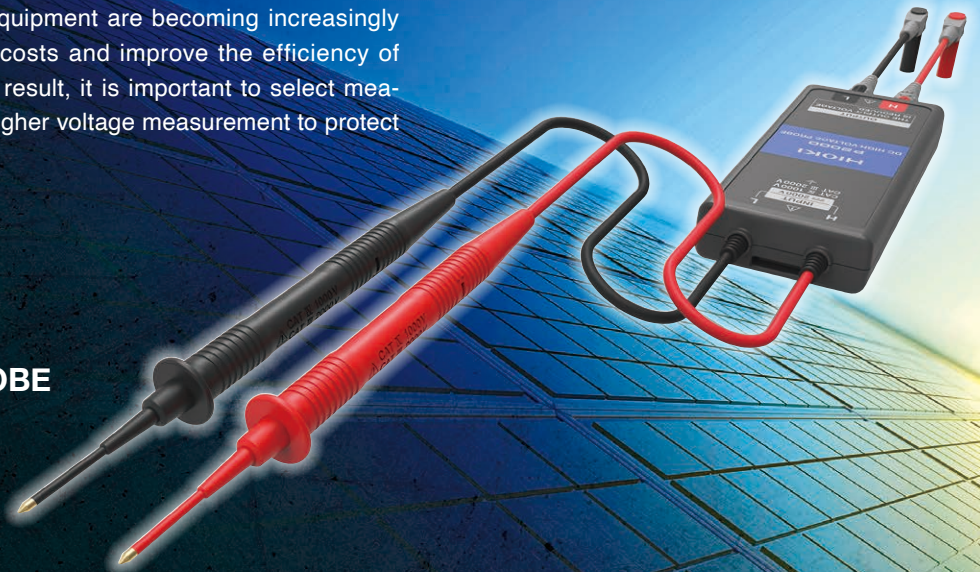

Safe testers that protect workers from dangerous accidents

Built-in voltage input terminal protection fuse to prevent internal short circuits



The DT4255's voltage input terminals incorporate a protective fuse so that contamination of the instrument's internal components with iron powder or other particulate matter will not result in an internal short-circuit. The fuse can be replaced easily on site.

Over-input warning function



To prevent an accident, a warning function immediately notifies the operator if the DMM receives excessively high input.

*Red screen available on high-end models and DT4261, DT4223, DT4224 only.

Terminal shutter to prevent accidental insertion



A range: Only the A and COM terminal inlets open.
V range: Only the V and COM terminal inlets open.

The DT4281, DT4282 and DT4261 use terminal shutters to keep probes from being inserted into the wrong inlets. The shutters block whichever terminal is not being used based on the selected measurement function.

Current measurement by AC clamp sensors to prevent accidents

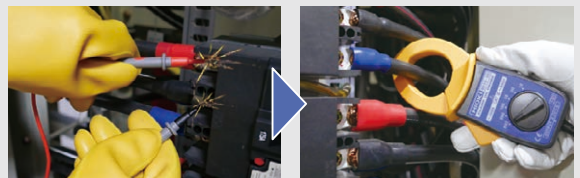

The DT4281, DT4261, DT4253, DT4255 and DT4256 eliminate the root cause of such accidents by providing clamp-on sensor-based current measurement functionality instead of using conventional probes.

Equipped with a protection circuit to prevent accidents from incorrect voltage input



Resistance range measurement circuit



Input-based switching of the measurement circuit

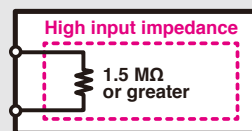

Switch to resistance range

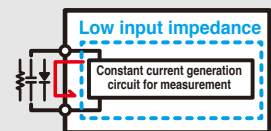

Detect input

Switch measurement circuit

The DT4223 and DT4224 are equipped with a protection circuit that prevents electrical accidents that occur when voltage is input in the resistance range. The measurement circuit is switched after the instrument detects resistance, continuity, capacitance, or diode input. Even if you mistakenly input voltage with the instrument set to the resistance range, the high input impedance will limit the current flowing to the instrument to 1.5 mA or less to prevent potential hazards.

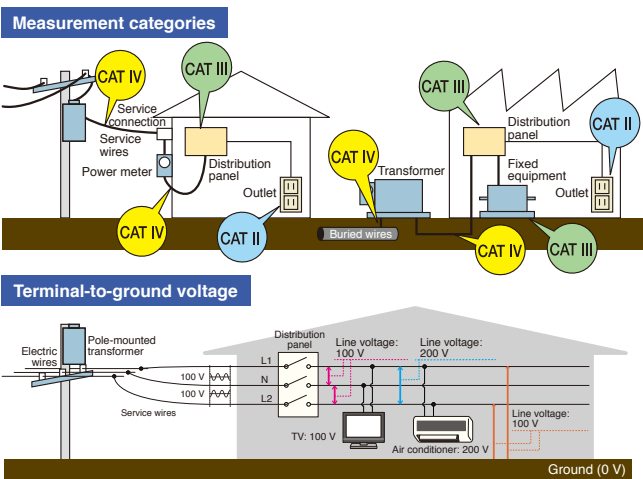

Safe measurement requires use of an instrument that suits the measurement location.

To ensure operators' ability to use measuring instruments safely, IEC 61010 classifies the locations in which instruments are used into a series of safety-based measurement categories (ranging from CAT II to CAT IV). Using an instrument that does not satisfy the required safety level can lead to an electrical accident.

CAT IV 600 V Terminal-to-ground voltage Measurement category suited to the location of use

High-end models	CAT III 1000 V / CAT IV 600 V
New Standard Model	CAT III 1000 V / CAT IV 600 V
Standard models	CAT III 1000 V / CAT IV 600 V
Pocket models	CAT III 600 V / CAT IV 300 V



Designed and manufactured in Japan to ensure high quality and guaranteed with a 3-year warranty for peace of mind



All development, design, and manufacturing processes for almost all Hioki digital multimeters are carried out at our Head Office in Nagano Prefecture. Some of the industry's most advanced technological capabilities enable us to deliver products of the highest possible quality.

Field-Proven Strength and Usability

DT4200 series

Robust design capable of withstanding a drop from a height of 1 m onto concrete



Drop tester

To test our products' ability to withstand mechanical shock, we repeatedly drop them from a height of at least 1 m until they break. This drop-testing regime leads to more robust products by fostering a series of design improvements.



Preventing instrument failure by keeping out dust



If dust gets into the instrument's enclosure, it can cause the device to fail. Since dust can get into the instrument especially easily through the gap around the rotary switch, the DT4200 series incorporates a dust-proof part known as an O-ring where the rotary switch is mounted to improve the device's dust resistance.

Fast, accurate measurement of the output voltage on the secondary side of an inverter

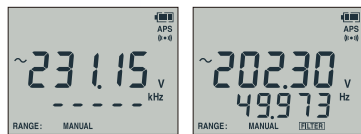

With low-pass filter off With low-pass filter on

The DT series can accurately measure the voltage on the secondary side of an inverter, just like a power meter. Its low-pass filter rejects harmonic components so that the fundamental wave can be isolated and accurately measured.

Outstanding viewing angle so display is easy to read at an angle or even in a dim location and rotary switch that's easy to operate even when wearing gloves



The display has a wide viewing angle and backlight function for easy viewing when the screen is not visible from the front or when measuring in dimly lit areas.



Rotary switch is designed to be easy to turn even when wearing thick work gloves, for example while working in hazardous measurement locations or harsh conditions.

True RMS measurement for accurate measurement of even distorted current waveforms

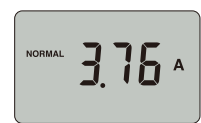
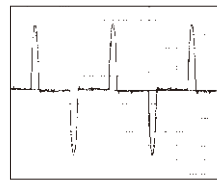

Average-value method measured value



True RMS method measured value

Current waveforms are often distorted, causing the average-value and true RMS measurement methods to yield different results. To obtain accurate readings, RMS measurement is indispensable.

Hand-free and easy to use



It's hard to carry out work tasks smoothly when you're juggling a measuring instrument, probes, recording paper, and other supplies. Field concerns like these are resolved by the DT4200's magnetic strap, auto-hold function*, and ability to save results in its internal memory. These capabilities boost work efficiency and help reduce work times.

*The auto-hold function is available exclusively in high-end, standard models and DT4261,DT4223,DT4224. The ability to save results in internal memory is available exclusively in high-end models.

New L9300 test leads with integrated cap*



*Included accessory for DT4261



Learn more about the L9300

Video ▶



3D view ▶



Test leads L9300 now incorporate integrated caps. The design lets you change the measurement category simply by sliding the test lead's protective finger guard. As an added bonus, you no longer have to worry about losing caps!

Extensive selection of probe tips that you can choose based on the measurement location, improving ease of measurement



With screw terminals



In deep-set locations that can't be reached with other probes



For clamping around the target busbar



With the DT4200, you can choose the probe type that best suits your measurement location, making it possible to measure in areas that can't be reached with conventional probes and busbars that you wish to clamp between probes.

*Compatible probe tips vary with the DMM model. Please see page 16. The optional Connection Cable L4930 is required in order to use the probes shown at the left.

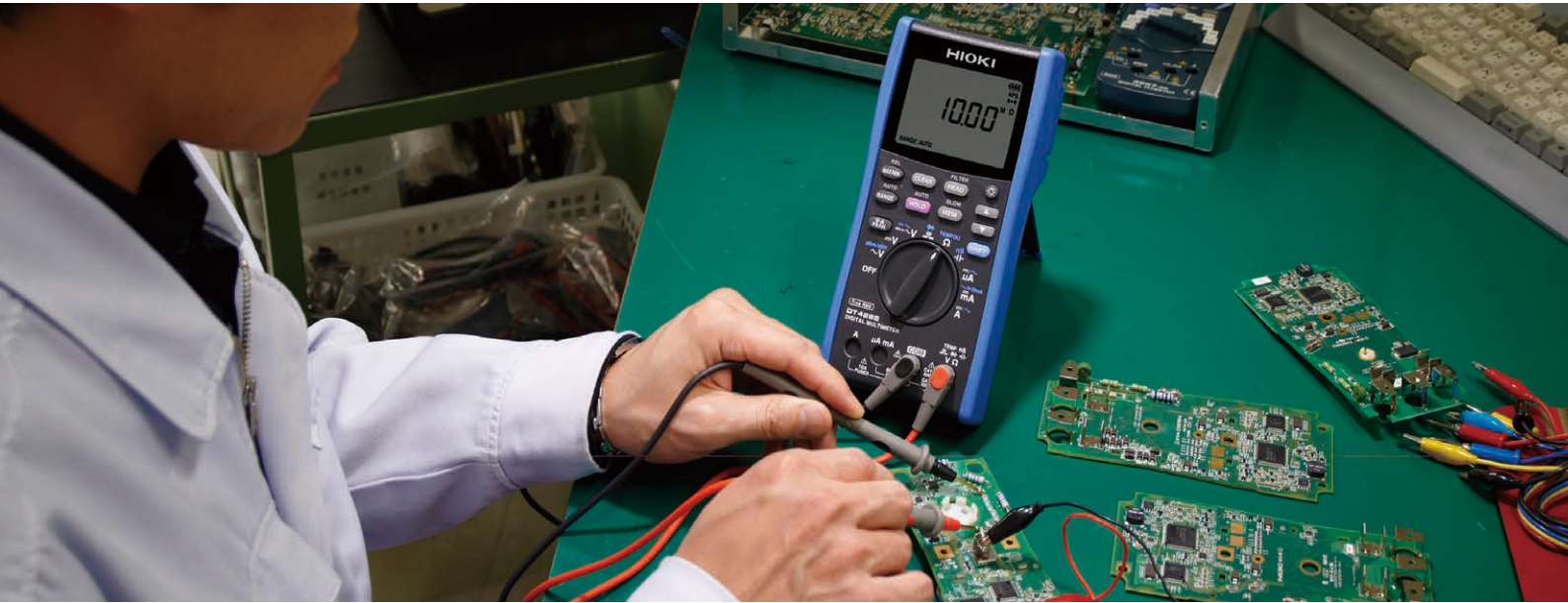

High-end models

Featuring high accuracy, extensive additional functionality, and a broad range of measurement parameters

DC V typical accuracy: $\pm 0.025\%$ rdg. ± 2 dgt.

Measurement categories: CAT III (1000 V), CAT IV (600 V)



For electrical work in the field

DT4281

Designed for maximum safety in the field when measuring current with clamp-on sensors.

DC voltage	60.000 mV to 1000.0 V
AC voltage	60.000 mV to 1000.0 V
DC + AC voltage	6.000 V to 1000.0 V
DC current	600.00 μ A to 600.00 mA
AC current	600.00 μ A to 600.00 mA
AC clamp-on measurement	Frequency
Resistance	Continuity check
Temperature	Diode test
Capacitance	Conductance
AC/DC automatic detection	Voltage detection function



For laboratory and research use

DT4282

Designed for use in laboratories and R&D applications where you wish to measure a wide variety of parameters.

DC voltage	60.000 mV to 1000.0 V
AC voltage	60.000 mV to 1000.0 V
DC + AC voltage	6.000 V to 1000.0 V
DC current	600.00 μ A to 10.000 A
AC current	600.00 μ A to 10.000 A
AC clamp-on measurement	Frequency
Resistance	Continuity check
Temperature	Diode test
Capacitance	Conductance
AC/DC automatic detection	Voltage detection function

● Supported measurement parameter ● Supported measurement parameter (with model-specific variations) ● Unsupported measurement parameter

*The range figures given indicate the instrument's measurement ranges (not the range of measurable values).

Functions and Features



Magnetic strap frees both hands for work

Using the magnetic strap (option)

By using the magnetic strap to secure the instrument to the wall, you can free both hands so that you can more easily record measured values, significantly boosting work efficiency.



Automatically hold display values and save results with one touch to the DMM's internal memory

The display is automatically held once the measured value stabilizes. You can save measurement results to the instrument's internal memory simply by pressing the MEM key, making it easy to read and record values during inspection work.



Manage measurement data on a computer

Using the Communication Package DT4900-01 (option)

Measurement results can be downloaded to a computer via a USB connection. Once downloaded, you can save them as a file (text format) or display them as a graph using the desired interval. Results can also be sent in real time while measurement is ongoing.

*The computer and multimeter are electrically isolated by means of optical communications so that data can be sent with peace of mind.



Measure output voltage on the secondary sides of inverters

Accurately measure the fundamental wave alone by eliminating harmonic components with the DMM's low-pass filter function.

With low-pass filter off	With low-pass filter on
<p>~23.15 V kHz</p>	<p>~202.30 V 499.73 Hz</p>
<p>0 V</p> <p>Fundamental component + Harmonic component</p>	<p>0 V</p> <p>Fundamental component + Harmonic component</p>



Ripple voltage confirmation of DC charging systems

Peak value measurement / DC + AC voltage measurement

High-end models can detect ripple voltage with a superposed DC signal.

Input waveform
114.1 V 85.9 V 100 V

DC + AC measurement* ▶ 100.49 V

*DC + AC value = $\sqrt{(AC)^2 + (DC)^2}$

+Peak measurement ▶ 114.10 V
-Peak measurement ▶ 85.90 V



Percentage display for instrumentation signal measurement

4 to 20 mA / 0 to 20 mA percentage-equivalent display

You can check percentage-equivalent values.

Output 1	Display
4 mA	0%
20 mA	100%

Output 2	Display
4 mA	0%
20 mA	100%

Temperature
Pressure
Flow rate

Transducer



Measure very low currents used by gas-burning devices

DC μA range

High-end models provide a DC 600.00 μA range for measuring burner flame currents.

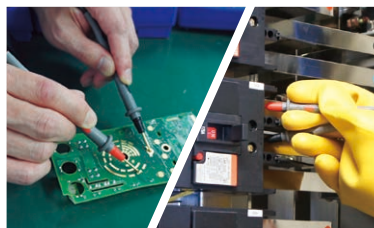
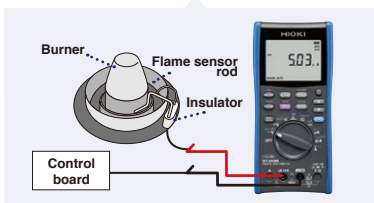

Intuitive notification of continuity check results and excessively high input with a red screen backlight and beep

High-end models notify the operator of continuity check results and excessively high input with a red screen backlight and beep, making it possible to check measurement results intuitively.

Continuous state Excessively high input

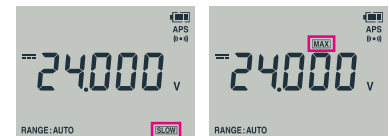

Display refresh rate

Change the display refresh speed to stabilize the display when performing measurement characterized by a high level of variability.

Maximum/minimum value display

Check the maximum and minimum measured values shown on the display after pressing the MAX/MIN button.

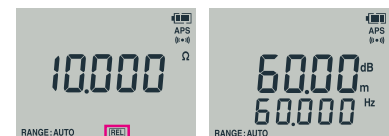

Relative display

View relative values using the display value before the relative function was enabled as the reference.

Decibel conversion

Convert the results of AC voltage measurement to a decibel value relative to a reference value and display the results (dbm/dbv).



New standard model

Supports wireless communication to increase work efficiency.
High voltage measurement up to CAT III 2000 V by connecting a dedicated probe.

DC V typical accuracy: $\pm 0.15\%$ rdg. ± 2 dgt.
Measurement categories: CAT III (1000 V), CAT IV (600 V)

Safe Inspection of Solar Installations with High Voltage

NEW

DC HIGH VOLTAGE PROBE P2000



By connecting the optional DC High Voltage Probe P2000, high voltage measurement up to CAT III 2000 V is now possible.

NEW



Multi-functional, on-site maintenance, mega solar DT4261

Go wireless with the Z3210!
For trouble analysis in the field.

Easily go wireless and manage your data digitally

WIRELESS ADAPTER Z3210



Wireless communication is supported in combination with the wireless adapter Z3210 (sold separately). In addition to working with the free "GENNECT Cross" application, the Excel® direct input function can also be used.

Why is CAT III 2000 V capability necessary?

According to the standards for Photovoltaic (PV) module safety qualification (IEC 61730-1), PV modules are treated as the overvoltage category III, and a measuring instrument in the measurement category III is required. Using instruments that can accommodate the appropriate measurement category serves to protect workers and equipment from serious accidents such as electric shock and burnout. Currently, adoption of 1500 V solar installation is growing, but instruments that can accommodate even higher voltages will be necessary in the future as larger and even more efficient systems enter into use.

DC voltage	600.0 mV to 1000 V
AC voltage	6.000 V to 1000 V
DC + AC voltage	6.000 V to 1000 V
DC current	600.0 mA to 10.00 A
AC current	600.0 mA to 10.00 A
AC clamp-on measurement	Frequency
Resistance	Continuity check
Temperature	Diode test
Capacitance	Conductance
AC/DC automatic detection	Voltage detection function

NEW DT4261-90
(Z3210 set product)

The DT4261-90, a set of DT4261 and Z3210, is also available. It is more economical than purchasing the DT4261 and Z3210 separately, and allows you to build a wireless communication environment with one purchase.



● Supported measurement parameter ● Unsupported measurement parameter

*The range figures given indicate the instrument's measurement ranges. Not the range of measurable values. Please see page 16 for details.

Link with GENNECT Cross



Troubleshoot in the field

When combined with GENNECT Cross, the DT4261 you can perform simple harmonic analysis. Applications include harmonic measurement of power conditioners for solar systems and problem analysis of power supply systems.

Problems that can be caused by harmonics

- Equipment burn-out and destruction due to overheating
- Malfunctions of power control devices
- Reduced service life and efficiency for power devices

Excel® Direct Input Function

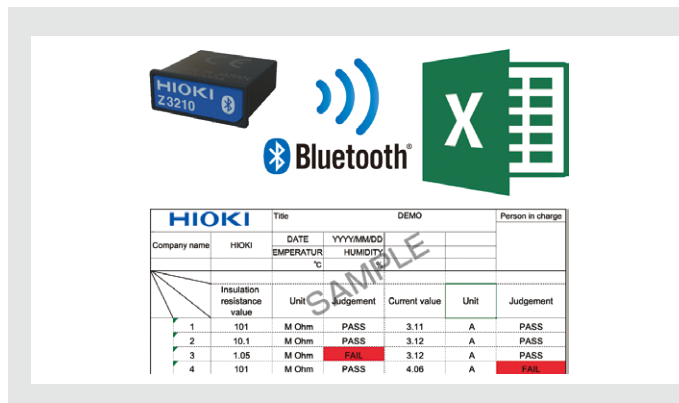

Improve work efficiency! Labor-saving measurement with digitalization

The wireless adapter Z3210 (sold separately) comes standard with an Excel® direct input function. It enables direct transfer and input of measurement data to templates created in Excel® leading to increased work efficiency in the field.

Functions and Features



Terminal shutter closes on unused terminals depending on the measurement function

The DT4261's terminal shutters are linked to the instrument's rotary switch. They block access to test lead terminals that aren't being used, making it physically impossible to insert a lead into the wrong terminal.

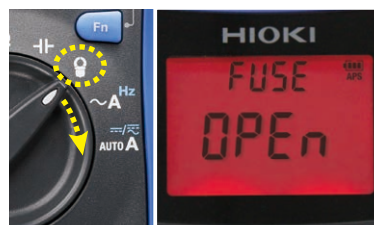

Prevents incorrect current measurement with the Fuse Check function

When switching from the clamp function to the current function, a fuse disconnection check is automatically performed. This allows the user to know if the fuse is broken before current measurement, which prevents erroneous measurement.



Automatic switching of measurement in locations where AC and DC voltages are mixed

When making measurements in locations with both AC and DC voltages, automatic switching eliminates the need to operate the rotary switch and helps prevent measurement mistakes.

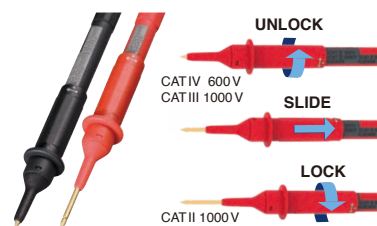

Test leads with an integrated cap for greater convenience and safety

The L9300 test lead with an integrated cap is included as a standard. The finger guard can be easily slid to switch between measurement categories without worrying about losing the cap.

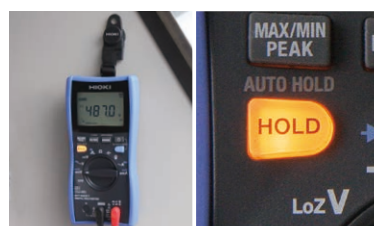

Free up hands for work with the magnetic strap* and auto-hold function

*The Magnetic Strap is sold separately
By using the magnetic strap to secure the instrument to the wall and the auto-hold function to automatically stop display values, you can free your hands, making it easier to record measured values and significantly boosting work efficiency.



Manage measurement data on a computer

Using the Communication Package DT4900-01 (sold separately)

Measurement results can be downloaded to a computer via a USB connection. Once downloaded, you can save them as a file (text format) or display them as a graph using the desired interval. Results can also be sent in real time while measurement is ongoing.

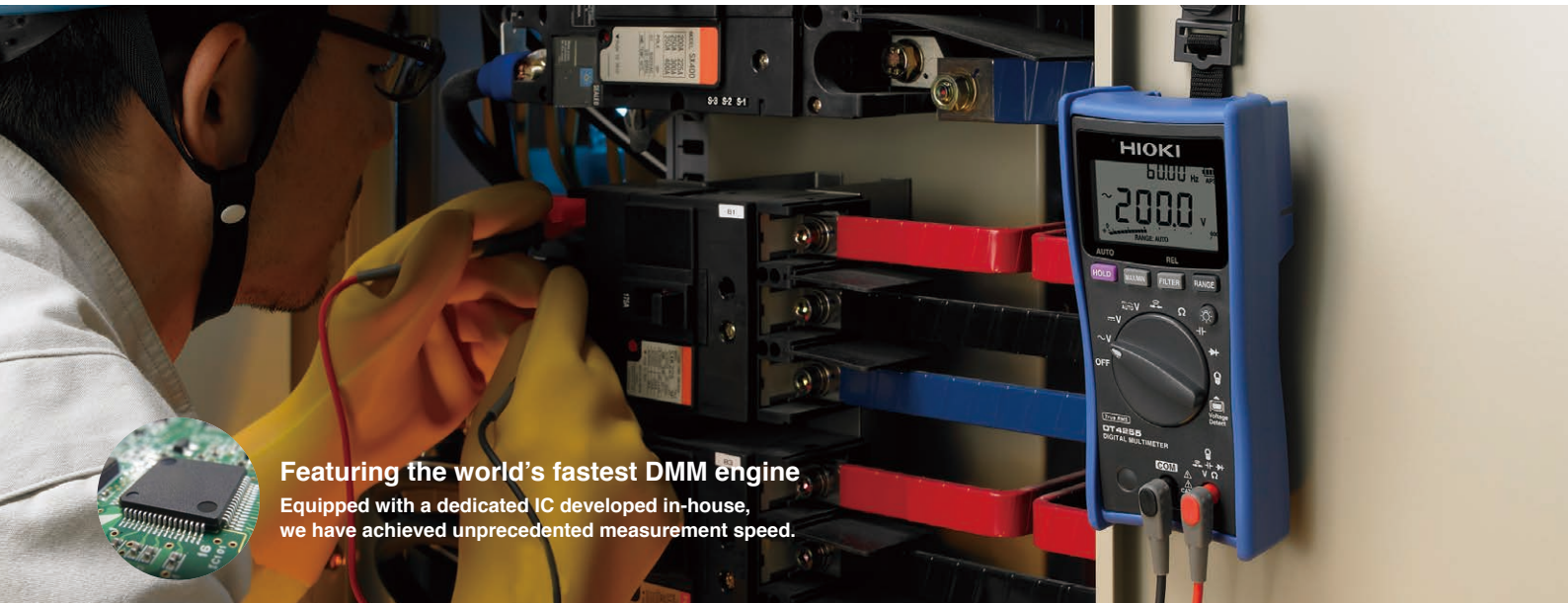

Featuring the world's fastest DMM engine
 Equipped with a dedicated IC developed in-house,
 we have achieved unprecedented measurement speed.

Standard models

Introducing a line of field-optimized instruments that
 can be chosen based on the application at hand

DC V typical accuracy: $\pm 0.3\%$ rdg. ± 3 dgt.
 Measurement categories: CAT III (1000 V), CAT IV (600 V)



For laboratory and research use
DT4252

For laboratories and R&D applications where you wish to measure a wide variety of parameters.



For instrumentation
 4-20 mA
DT4253

Measure instrumentation, air-conditioning equipment, and gas-burning devices.



For electrical work in the field
DT4255

Designed for maximum safety with voltage measurement terminals that are protected by a fuse.



Multifunction model
DT4256

Delivers maximum functionality for use in a wide range of settings.

DC voltage	600.0 mV to 1000 V
AC voltage	6.000 V to 1000 V
DC + AC voltage	DT4281/4282 only
DC current	6.000 A to 10.00 A
AC current	6.000 A to 10.00 A
AC clamp-on measurement	Frequency
Resistance	Continuity check
Temperature	Diode test
Capacitance	Conductance
AC/DC automatic detection	Voltage detection function

DC voltage	600.0 mV to 1000 V
AC voltage	6.000 V to 1000 V
DC + AC voltage	DT4281/4282 only
DC current	60.00 μ A to 60.00 mA
AC current	n/a
AC clamp-on measurement	Frequency
Resistance	Continuity check
Temperature	Diode test
Capacitance	Conductance
AC/DC automatic detection	Voltage detection function

DC voltage	600.0 mV to 1000 V
AC voltage	6.000 V to 1000 V
DC + AC voltage	DT4281/4282 only
DC current	n/a
AC current	n/a
AC clamp-on measurement	Frequency
Resistance	Continuity check
Temperature	Diode test
Capacitance	Conductance
AC/DC automatic detection	Voltage detection function

DC voltage	600.0 mV to 1000 V
AC voltage	6.000 V to 1000 V
DC + AC voltage	DT4281/4282 only
DC current	60.00 mA to 10.00 A
AC current	600.0 mA to 10.00 A
AC clamp-on measurement	Frequency
Resistance	Continuity check
Temperature	Diode test
Capacitance	Conductance
AC/DC automatic detection	Voltage detection function

● Supported measurement parameter ● Supported measurement parameter (with model-specific variations) ● Unsupported measurement parameter
 The range figures given indicate the instrument's measurement ranges (not the range of measurable values).

*Your instrument can be used to measure voltages in excess of 1000 V DC if and only if both of the following conditions are satisfied:
 1. The circuit under measurement is isolated from the commercial power grid. 2. The circuit under measurement is isolated from ground.

Functions and Features



Magnetic strap and auto-hold function free up hands for easier work

Using the magnetic strap (option)

By using the magnetic strap to secure the instrument to the wall and the auto-hold function to automatically stop display values, you can free your hands, making it easier to record measured values and significantly boosting work efficiency.

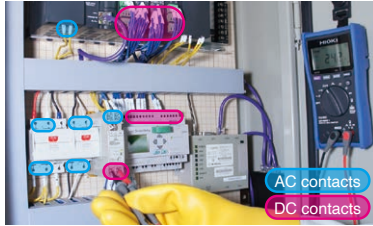

Automatic switching of measurement in locations where AC and DC voltages are mixed

AC/DC voltage automatic detection (DT4253, DT4255, DT4256 only)

When making measurements in locations with both AC and DC voltages, automatic switching eliminates the need to operate the rotary switch and helps prevent measurement mistakes.



Use a computer in the field to save and check measured values

With the Communication Package DT4900-01 (option)

Measured values can be displayed in real time on a computer, and displayed values can be saved to a file (text format) or graphed at a user-specified interval.

*The computer and multimeter are electrically isolated by means of optical communications so that data can be sent with peace of mind.



Measure output voltage on the secondary sides of inverters

Accurately measure the fundamental wave by eliminating harmonic components with the DMM's low-pass filter function.

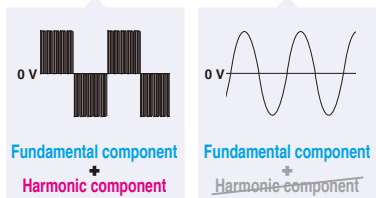
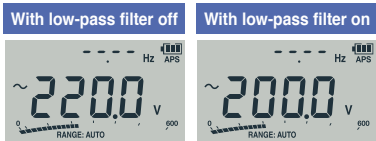

Over-input warning function

To prevent an accident, a warning function immediately notifies the operator if the DMM receives excessively high input.

Polarity detection and notification

Certain standard models can detect a load voltage in excess of -10 V and notify the operator with a red LED and beep.

(DT4255, DT4256 only)



Percentage display for instrumentation signal measurement

4 to 20 mA percentage-equivalent display (DT4253, DT4256 only)

The standard models' dual display function lets you to simultaneously check measured values and percentage-equivalent values at a glance.

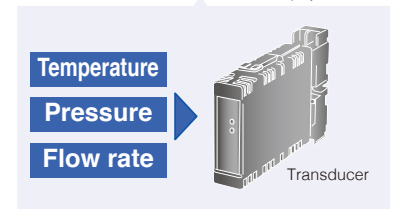
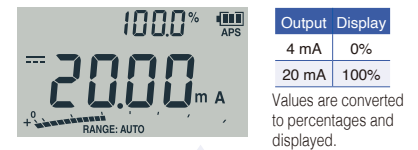

Measure very low currents used by gas-burning devices

DC μ A range (DT4253 only)

Model DT4253 provides a DC 60.00 μ A range for measuring burner flame currents.

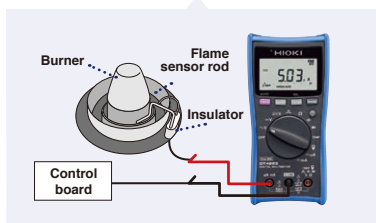

Intuitive notification of continuity check results and excessively high input with a red LED and beep

Standard models notify the operator of continuity check results and excessively high input with a red LED and beep, making it possible to check measurement results intuitively.



Thorough prevention of short-circuit accidents

Voltage measurement terminal fuse (DT4255 only)

When using the resistance measurement function, a protective circuit functions to prevent a short-circuit accident in the event of erroneous operation such as improperly supplying voltage input. Even if a short-circuit occurs inside the tester, a current-limiting resistor will limit any short-circuit current while a fast-blow fuse quickly and reliably disconnects the tester circuitry, preventing a short-circuit accident.

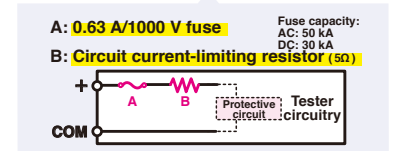



Featuring the world's fastest DMM engine
 Equipped with a dedicated IC developed in-house,
 we have achieved unprecedented measurement speed.



Pocket models

Featuring a compact body for ergonomic hold
 and a reliable, safe design

DC V typical accuracy: $\pm 0.5\%$ rdg. ± 5 dgt.
 Measurement categories: CAT III (600 V), CAT IV (300 V)



**For electrical
 work in the field**

DT4221

Delivering maximum field safety
 for workers whose principal use
 is voltage measurement.



**For multiple
 applications**

DT4222

For laboratories and R&D
 applications to measure a wide
 variety of parameters.



**For electrical
 work in the field**

DT4223

Delivering maximum field safety
 for workers whose principal use
 is voltage measurement.

Circuit breaker
 false trip
 prevention built-in



**For multiple
 applications**

DT4224

For laboratories and R&D
 applications to measure a wide
 variety of parameters.

DC voltage	600.0 mV to 600.0 V
AC voltage	6.000 V to 600.0 V
DC + AC voltage	DT4281/4282 only
DC current	n/a
AC current	n/a
AC clamp-on measurement	Frequency
Resistance	Continuity check
Temperature	Diode test
Capacitance	Conductance
AC/DC automatic detection	Voltage detection function

DC voltage	600.0 mV to 600.0 V
AC voltage	6.000 V to 600.0 V
DC + AC voltage	DT4281/4282 only
DC current	n/a
AC current	n/a
AC clamp-on measurement	Frequency
Resistance	Continuity check
Temperature	Diode test
Capacitance	Conductance
AC/DC automatic detection	Voltage detection function

DC voltage	600.0 mV to 600.0 V
AC voltage	6.000 V to 600.0 V
DC + AC voltage	DT4281/4282 only
DC current	n/a
AC current	n/a
AC clamp-on measurement	Frequency
Resistance	Continuity check
Temperature	Diode test
Capacitance	Conductance
AC/DC automatic detection	Voltage detection function

DC voltage	600.0 mV to 600.0 V
AC voltage	6.000 V to 600.0 V
DC + AC voltage	DT4281/4282 only
DC current	n/a
AC current	n/a
AC clamp-on measurement	Frequency
Resistance	Continuity check
Temperature	Diode test
Capacitance	Conductance
AC/DC automatic detection	Voltage detection function

● Supported measurement parameter ● Supported measurement parameter (with model-specific variations) ● Unsupported measurement parameter

*The range figures given indicate the instrument's measurement ranges (not the range of measurable values).

Functions and Features

New DT4223 and DT4224 feature circuit breaker false trip prevention



Prevent potential accidents during incorrect input

The measurement circuit switches only after detecting the appropriate signal. This way, even if you mistakenly input voltage, accidents due to tripped breakers or arcs will not happen. (see page 2)



LoZ icon identifies switched measurement circuit

When the instrument detects resistance, continuity, capacitance, or diode input, the LoZ icon is shown on the display, allowing you to identify at a glance which measurement circuit has been selected.



Warning function notifies you of incorrect input.

The instrument's display flashes red to warn you when voltage has been mistakenly input while the instrument is set to the resistance range.



Compact and lightweight design for outstanding ease of use

The small form factor fits in your hand perfectly and is easily stowable, making it convenient to transport to and from the field and boosting work efficiency. The lightweight design also ensures that pocket models are easy to work with.



Safe enough for measuring voltage at distribution panels and service wires

Despite a compact body, the pocket models can be used to measure voltage at distribution panels and service wires in CAT III (600 V), CAT IV (300 V) situations.

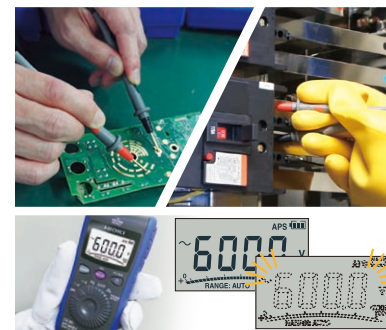

Intuitive notification of excessively high input with flashing screen

The pocket digital multimeters notify the operator of excessively high input by flashing the screen, making it possible to check measurement results intuitively.

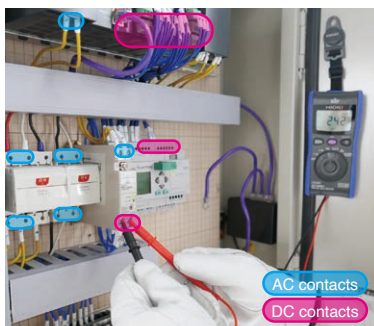

Automatic switching of measurement in locations where AC and DC voltages are mixed

AC/DC voltage automatic detection (DT4221, DT4223 only)

When making measurements in locations with both AC and DC voltages, automatic switching eliminates the need to operate the rotary switch and helps prevent measurement mistakes.

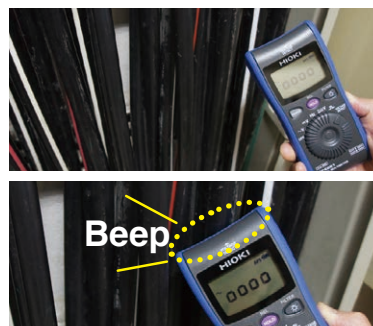

Detect voltage simply by holding the instrument against a wire

Voltage detection function (DT4221, DT4223 only)











Easily detect voltage with the built-in sensor. Results are communicated with a beep.



Fast measurement for outstanding ease of use

Measured values are displayed quickly to facilitate quick testing. The difference is clear when you compare the measurement speed with that of the Hioki Card HiTESTER 3244-60.

DT4200 Series Basic Comparison

Model category	High-end models		New standard models	Standard models				Pocket models			
Measurement type	Electrical work	General use	General use/ mega Solar	General use	Air conditioning/ instrumentation	Electrical work	General use	Electrical work	General use	Electrical work	General use
Model	DT4281	DT4282	DT4261 /DT4261-90*1	DT4252	DT4253	DT4255	DT4256	DT4221	DT4222	DT4223	DT4224
Appearance											
Basic Characteristics											
True RMS	✓		✓	✓				✓			
DC V basic accuracy	±0.025% rdg. ±2 dgt.		±0.15% rdg. ±2 dgt.	±0.3% rdg. ±5 dgt.		±0.3% rdg. ±3 dgt.		±0.5% rdg. ±5 dgt.			
Measurement items (Typical ranges are indicated; may not reflect maximum or minimum measurable signal)											
DC voltage	60 mV to 1000 V		600 mV to 1000 V, 2000V*2	600 mV to 1000 V				600 mV to 600 V			
AC voltage	60 mV to 1000 V		6 V to 1000 V	6 V to 600 V				6 V to 600 V			
DC V + AC V	6 V to 1000 V		6 V to 1000 V	n/a				n/a			
DC A current	600 µA to 600 mA	600 µA to 10 A	600 mA to 10 A	6 A to 10 A	60 µA to 60 mA	n/a	60 mA to 10 A	n/a			
AC A current	600 µA to 600 mA	600 µA to 10 A	600 mA to 10 A	6 A to 10 A	n/a		60 mA to 10 A	n/a			
AC clamp	10 A to 1000 A	n/a	10 A to 1000 A	n/a	10 A to 1000 A		n/a				
Resistance	60 Ω to 600 MΩ		600 Ω to 60 MΩ	600 Ω to 60 MΩ				n/a	600 Ω to 60 MΩ		
Temperature	-40°C to 800°C		n/a	n/a	-40°C to 400°C		n/a	n/a			
Capacitance	1 nF to 100 mF	1 µF to 10 mF		1 µF to 10 mF				n/a	1 µF to 10 mF	n/a	1 µF to 10 mF
Frequency	99 Hz to 500 kHz		99 Hz to 99 kHz	99 Hz to 99 kHz				99 Hz to 9.9 kHz			
Continuity check	✓		✓	✓				✓			
Diode check	✓		✓	✓				n/a	✓	n/a	✓
Conductance	n/a	✓	n/a	n/a				n/a			
Voltage detection	n/a		n/a	n/a	n/a		✓	✓	n/a	✓	n/a
Additional Functions											
AUTO AC/DC V	n/a		✓	n/a	✓		✓	n/a	✓	n/a	
Peak measurement	DC/AC		DC/AC	n/a				n/a			
Low-pass filter	Analog filter Cut-off: 630 Hz		Digital filter Pass-band: 100/500 Hz	Digital filter Pass-band: 100/500 Hz				Digital filter Pass-band: 100/500 Hz			
Display update setting	✓		n/a	n/a				n/a			
Hold display value	AUTO/MANUAL		AUTO/MANUAL	AUTO/MANUAL				MANUAL	AUTO/MANUAL		
Max/Min value display	✓ (Excluding average value display)		✓	✓				n/a			
Relative display	✓		n/a	✓				✓			
Decibel conversion	✓		n/a	n/a				n/a			
Percentage conversion display	✓		n/a	n/a	✓	n/a	✓	n/a			
DC voltage polarity check	✓		n/a	n/a	n/a		✓	n/a			
Data storage											
Capacity	Max 400 data		n/a	n/a				n/a			
USB communication*3	✓		✓	✓				n/a			
Bluetooth® communication*4	n/a		✓	n/a				n/a			
Operating time											
Continuous operating time	Approx. 100 hours*5		Approx. 130 hours*6	Approx. 130 hours				Approx. 40 hours	Approx. 35 hours		
Power supply	Alkaline (LR6) battery x4/ Manganese(R6P) battery x4		Alkaline (LR6) battery x3	Alkaline (LR03) battery x4				Alkaline (LR03) battery x1			
Display											
Back light	✓		✓	✓				✓			
Dual display	✓		✓	✓				n/a			
Bar graph display	n/a		✓	✓				✓			
Safety											
Safety standard categories	CAT III 1000 V, CAT IV 600 V		CAT III 1000 V, CAT IV 600 V	CAT III 1000 V, CAT IV 600 V				CAT III 600 V, CAT IV 300 V			
Mis-insertion prevention shutters	✓		✓	n/a				n/a			
Circuit breaker false trip prevention	n/a		n/a	n/a				n/a	✓		

*1. Z3210 set product *2. 2000 V is supported only when using the optional DC HIGH VOLTAGE PROBE P2000

*3. Requires optional DT4900-01 Communication Package *4. Requires optional Z3210 wireless adapter *5. When using four AA alkaline batteries *6. When Z3210 is not installed

Glossary

Auto AC/DCV : Automatically detects and measures AC and DC voltage. | **Peak measurement** : After starting PEAK value measurement, check maximum and minimum instantaneous voltage and current values. | **Low-pass filter** : Cuts high frequency content to provide stable numerical values for measurement. | **Display update setting** : Reduces the display value update rate to stabilize measurements. | **Hold display value** : Manual: press the button to freeze the display. Auto: the display freezes automatically when the measurement value is stable. | **Max/Min value display** : Pressing the MAX/MIN button displays the maximum and minimum displayed measurement values. | **Relative display** : Pressing the REL button displays subsequent measurements as values relative to that displayed when the button was pressed. | **Decibel conversion** : Displays AC voltage measurements converted to decibel values (dbm/dbv) | **Percentage conversion display** : Displays 4 to 20 mA (or 0 to 20 mA) signals converted to 0 to 100% values. For the DT4253, only 4 to 20 mA.

High-End DT4281 / DT4282

(Accuracy guaranteed for 1 year)

DC Voltage		
Range	Accuracy	Input Impedance
60.000 mV	±0.2% rdg. ±25 dgt.	1 GΩ or more // 100 pF or less
600.00 mV	±0.025% rdg. ±5 dgt.	
6.0000 V	±0.025% rdg. ±2 dgt.	11.0 MΩ ±2% // 100 pF or less
60.000 V		10.3 MΩ ±2% // 100 pF or less
600.00 V		10.2 MΩ ±2% // 100 pF or less
1000.0 V		

AC Voltage						
Range	Accuracy					
	20Hz to 45Hz	45Hz to 65Hz	65Hz to 1kHz	1kHz to 10kHz	10kHz to 20kHz	20kHz to 100kHz
60.000 mV	±1.3% rdg. ±60 dgt.	±0.4% rdg. ±40 dgt.	±0.0% rdg. ±40 dgt.	±0.9% rdg. ±40 dgt.	±1.5% rdg. ±40 dgt.	±20% rdg. ±80 dgt.
600.00 mV	±1% rdg. ±60 dgt.	±0.2% rdg. ±25 dgt.	±0.3% rdg. ±25 dgt.	±0.4% rdg. ±25 dgt.	±0.7% rdg. ±40 dgt.	±3.5% rdg. ±40 dgt.
6.0000 V	±0.2% rdg. ±25 dgt.					
60.000 V	Undefined	±0.2% rdg. ±25 dgt.	±0.3% rdg. ±25 dgt.	±0.4% rdg. ±25 dgt.	±0.7% rdg. ±40 dgt.	±3.5% rdg. ±40 dgt.
600.00 V						
1000.0 V						

DC V + AC V Measurement						
Range	Accuracy					
	20Hz to 45Hz	45Hz to 65Hz	65Hz to 1kHz	1kHz to 10kHz	10kHz to 20kHz	20kHz to 100kHz
6.0000 V	±1.2% rdg. ±65 dgt.	±0.3% rdg. ±30 dgt.	±0.4% rdg. ±30 dgt.	±0.4% rdg. ±30 dgt.	±1.5% rdg. ±45 dgt.	±3.5% rdg. ±125 dgt.
60.000 V	±0.3% rdg. ±30 dgt.					
600.00 V	Undefined	±0.3% rdg. ±30 dgt.	±0.4% rdg. ±30 dgt.	±0.4% rdg. ±45 dgt.	Undefined	Undefined
1000.0 V						

Input impedance: 1 MΩ ±4% // 100 pF or less

Crest factor: 3 or less (1.5 or less for the 1000.0 V range)

Accuracy specification range: 5% or more of each range

With the filter ON, accuracy is defined only for frequencies 100 Hz or less. Furthermore, 2% rdg. is added.

DC A Measurement *1. DT4282 only			
Range	Accuracy / Display update : slow	Accuracy / Display update : normal	Shunt Resistance
600.00 μA	±0.05% rdg. ±5 dgt.	±0.05% rdg. ±25 dgt.	101 Ω
6000.0 μA		±0.05% rdg. ±5 dgt.	
60.000 mA		±0.05% rdg. ±25 dgt.	
600.00 mA	±0.15% rdg. ±5 dgt.	±0.15% rdg. ±5 dgt.	1 Ω
6.0000 A ⁺		±0.2% rdg. ±25 dgt.	
10.000 A ⁺	±0.2% rdg. ±5 dgt.	±0.2% rdg. ±25 dgt.	10 mΩ
		±0.2% rdg. ±5 dgt.	

AC A Measurement *1. DT4282 only					
Range	Accuracy				
	20Hz to 45 Hz	45Hz to 65 Hz	65Hz to 1 kHz	1kHz to 10 kHz	10kHz to 20 kHz
600.00 μA	±1.0% rdg. ±20 dgt.	±0.6% rdg. ±20 dgt.	±0.6% rdg. ±20 dgt.	±2% rdg. ±20 dgt.	±4% rdg. ±20 dgt.
6000.0 μA	±1.0% rdg. ±5 dgt.	±0.6% rdg. ±5 dgt.	±0.6% rdg. ±5 dgt.	±2% rdg. ±5 dgt.	±4% rdg. ±5 dgt.
60.000 mA	±1.0% rdg. ±20 dgt.	±0.6% rdg. ±20 dgt.	±0.6% rdg. ±20 dgt.	±1% rdg. ±20 dgt.	±2% rdg. ±20 dgt.
600.00 mA	±1.0% rdg. ±5 dgt.	±0.6% rdg. ±5 dgt.	±0.6% rdg. ±5 dgt.	±1.5% rdg. ±10 dgt.	Undefined
6.0000 A ⁺	Undefined	±0.8% rdg. ±20 dgt.	±0.8% rdg. ±20 dgt.	Undefined	Undefined
10.000 A ⁺	Undefined	±0.8% rdg. ±5 dgt.	±0.8% rdg. ±5 dgt.	Undefined	Undefined

Shunt resistance: μA Range 101 Ω, mA Range 1Ω, A Range 10 mΩ

Crest factor: 3 or less (Note that it applies to 1/2 of the range.)

Accuracy specification range: Accuracy is not defined for measurements below 5% of range

Continuity Check			
Range	Accuracy	Measurement Current	Open-terminal Voltage
600.0 Ω	±0.5% rdg. ±5 dgt.	640 μA ±10%	DC 2.5 V or less

Continuity threshold: 20 Ω (default), 50 Ω, 100 Ω, 500 Ω

Diode Check			
Range	Accuracy	Measurement Current	Open-terminal Voltage
3.600 V	±0.1% rdg. ±5 dgt.	1.2 mA or less	DC 4.5 V or less

Forward threshold: 0.15 V, 0.5 V (default), 1 V, 1.5 V, 2 V, 2.5 V, 3 V

If the reading is lower than the threshold during the forward connection, a buzzer sounds and the red backlight turns on.

AC Clamp (AC Current) DT4281 only		
Range	Accuracy	
	40 Hz to 65 Hz	65 Hz to 1 kHz
10.00 A	±0.6% rdg. ±2 dgt.	±0.9% rdg. ±2 dgt.
20.00 A	±0.6% rdg. ±4 dgt.	±0.9% rdg. ±4 dgt.
50.00 A	±0.6% rdg. ±10 dgt.	±0.9% rdg. ±10 dgt.
100.0 A	±0.6% rdg. ±2 dgt.	±0.9% rdg. ±2 dgt.
200.0 A	±0.6% rdg. ±4 dgt.	±0.9% rdg. ±4 dgt.
500.0 A	±0.6% rdg. ±10 dgt.	±0.9% rdg. ±10 dgt.
1000 A	±0.6% rdg. ±2 dgt.	±0.9% rdg. ±2 dgt.

The optional 9010-50, 9018-50, or 9132-50 CLAMP ON PROBE is used. Accuracy does not include the error of the clamp-on probe.

Crest factor: 3 or less

Accuracy is not defined for measurements below 15% of range

Resistance Measurement			
Range	Accuracy	Measurement Current	Open-terminal Voltage
60.000 Ω	±0.3% rdg. ±20 dgt.	640 μA ±10%	DC 2.5 V or less
600.00 Ω	±0.03% rdg. ±10 dgt.		
6.0000 kΩ	±0.03% rdg. ±2 dgt.	96 μA ±10%	
60.000 kΩ		9.3 μA ±10%	
600.00 kΩ		0.96 μA ±10%	
6.0000 MΩ	±0.15% rdg. ±4 dgt.	96 nA ±10%	
60.00 MΩ	±1.5% rdg. ±10 dgt.		
600.0 MΩ	±3.0% rdg. ±20 dgt.		
	±8.0% rdg. ±20 dgt.		

Conductance (nS) DT4282 only			
Range	Accuracy	Measurement Current	Open-circuit Voltage
600.00 nS	±1.5% rdg. ±10 dgt.	96 nA ±10%	DC 2.5 V or less

Accuracy is defined for humidity 60% RH or less. Accuracy is defined for the range 20nS or more. In the case of 300 nS or more, ±20 dgt. is added.

Capacitance Measurement			
Range	Accuracy	Measurement Current	Open-circuit Voltage
1.000 nF	±1% rdg. ±20 dgt.	32 μA ±10%	DC 2.5 V or less
10.00 nF	±1% rdg. ±5 dgt.		
100.0 nF			
1.000 μF	±2% rdg. ±5 dgt.	680 μA ±20%	DC 3.1 V or less
10.00 μF			
100.0 μF			DC 2.1 V or less
1.000 mF			
10.00 mF			
100.0 mF	±2% rdg. ±20 dgt.		

Temperature		
Thermocouple Type	Range	Accuracy
K	-40.0°C to 800.0°C (-40.0°F to 1472.0°F)	±0.5% rdg. ±3°C (5.4°F)

The optional K Thermocouple DT4910 is used. Accuracy does not include the error of the K thermocouple.

Frequency (For AC V, DC + AC V, AC μA, AC mA, AC A)	
Range	Accuracy
99.999 Hz	±0.005% rdg. +3 dgt.
999.99 Hz	
9.9999 kHz	
99.999 kHz	
500.00 kHz	

Measurement range: 0.5 Hz or more ([---] is displayed when frequency is less than 0.5 Hz)

Pulse width: 1 μs or more (DUTY ratio is 50%)

With the filter ON, accuracy is defined only for frequencies 100 Hz or less. (For ACV, DC+ACV)

Peak Measurement (For AC V, DC V, DC+AC V, Clamp, DC μA, DC mA, DC A, AC μA, AC mA, AC A)		
Main measurement	Signal width	Accuracy
DC V	4 ms or more (single)	±2.0% rdg. ±40 dgt.
	1 ms or more (repeated)	±2.0% rdg. ±100 dgt.
Other than DC V	1 ms or more (single)	±2.0% rdg. ±40 dgt.
	250 μs or more (repeated)	±2.0% rdg. ±100 dgt.

Decibel Conversion Measurement : Standard impedance (dBm)	
4, 8, 16, 32, 50, 75, 93, 110, 125, 135, 150, 200, 250, 300, 500, 600, 800, 900, 1000, 1200 Ω	(default: 600 Ω)

High-End General Specifications

Durability	
Drop proof	Yes
Operating temperature and humidity*1	-15°C to 55°C
Storage temperature and humidity*2	-30°C to 60°C
Applicable standards	Safety: EN61010, EMC: EN61326; Waterproof and dustproof: IP40

*1. -15°C to 55°C (5°F to 131°F), Up to 40°C (104°F): at 80% RH or less (non-condensating),
40°C to 45°C (104°F to 113°F): at 60% RH or less (non-condensating),
45°C to 55°C (113°F to 131°F): at 50% RH or less (non-condensating)

*2. 80%RH or less (non-condensating)

Dimensions/Weight

93W × 197H × 53D mm (3.66"W × 7.76"H × 2.09"D),
650 g (23 oz.) (including batteries)

Safety	
Maximum rated voltage between input terminals and ground	CAT III 1000 V, CAT IV 600 V
Maximum rated voltage between terminals	Between the V and COM terminals: 1000 V DC/AC
Maximum rated current between terminals	Between the mA and COM terminals: 600 mA DC/600 mA AC Between the A and COM terminals: 10 A DC/10 A AC

Included accessories

TEST LEAD L9207-10, Instruction Manual, LR6 alkaline battery × 4

New Standard NEW DT4261

(Accuracy guaranteed for 1 year)

DC Voltage		
Range	Accuracy*1	Input Impedance
600.0 mV	±0.15% rdg. ±5 dgt.	11.3 MΩ ± 2.0%
6.000 V		
60.00 V	±0.15% rdg. ±2 dgt.	10.4 MΩ ± 2.0%
600.0 V		
1000 V	±0.15% rdg. ±5 dgt.	10.3 MΩ ± 1.5%
2000 V*2	±0.5% rdg. ±5 dgt.	20 MΩ ± 5.0%

*1. Add ±1 dgt. when measuring at or below 5% of range

*2. 2000 V is supported only when using the optional DC HIGH VOLTAGE PROBE P2000

AC Voltage			
Range	Accuracy		Input Impedance
	40 Hz to 500 Hz	500 Hz to 1 kHz	
6.000 V	±0.9% rdg. ±3 dgt.	±1.5% rdg. ±3 dgt.	11.3 MΩ ± 2.0% // 100 pF or less
60.00 V			
600.0 V			
1000 V			
Crest factor	3 at up to 4000 counts and reduces linearly to 2 at 6000 counts. 1000 V range only: 2 at up to 750 counts, linearly decreasing to 1.5 at 1000 counts.		
Accuracy specification range	For ACV, minimum 1% of range; add ±5 dgt. when measuring at or below 5% of range.		

DC A Measurement		
Range	Accuracy	Input Impedance
600.0 mA	±0.5% rdg. ±3 dgt.	35 mΩ ±30%
6.000 A		
10.00 A		
Accuracy specification range	Add ±2 dgt. when measuring at or below 5% of range.	

AC A Measurement			
Range	Accuracy		Input Impedance
	40 Hz to 500 Hz	500 Hz to 1 kHz	
600.0 mA	±1.4% rdg. ±3 dgt.	±1.8% rdg. ±3 dgt.	35 mΩ ±30%
6.000 A			
10.00 A			
Crest factor	3 at up to 4000 counts and reduces linearly to 2 at 6000 counts.		
Accuracy specification range	For ACV, minimum 1% of range; add ±5 dgt. when measuring at or below 5% of range.		

Continuity Check			
Range	Accuracy	Measurement Current	Open-terminal Voltage
600.0 Ω	±0.7% rdg. ±5 dgt.	Approx. 200 μA	DC 2.0 V or less
Continuity ON threshold	Approx. 25 Ω or less (continuous buzzer sound, red backlight on)		
Continuity OFF threshold	Approx. 245 Ω or more (buzzer sound off, red backlight off)		

Diode Check			
Range	Accuracy	Measurement Current	Open-terminal Voltage
1.800 V	±0.5% rdg. ±5 dgt.	Approx. 200 μA	DC 2.0 V or less
Forward threshold	Intermittent buzzer sound at 0.15 V to 1.8 V, continuous buzzer sound at less than 0.15 V, red backlight on.		

AC Clamp (AC Current)		
Range	Accuracy	
	40 Hz to 500 Hz	500 Hz to 1 kHz
10.00 A	±0.9% rdg. ±3 dgt.	±1.5% rdg. ±3 dgt.
20.00 A		
50.0 A		
100.0 A		
200.0 A		
500 A		
1000 A		

The optional 9010-50, 9018-50, or 9132-50 CLAMP ON PROBE is used.
Accuracy does not include the error of the clamp-on probe.

Crest factor 3 or less

Accuracy specification range Minimum 1% of range; add ±5 dgt. when measuring at or below 5% of range

Resistance Measurement			
Range	Accuracy	Measurement Current	Open-terminal Voltage
600.0 Ω	±0.7% rdg. ±5 dgt.	Approx. 200 μA	DC 2.0 V or less
6.000 kΩ		Approx. 100 μA	
60.00 kΩ		Approx. 10 μA	
600.0 kΩ	±0.9% rdg. ±3 dgt.	Approx. 1 μA	
6.000 MΩ		Approx. 100 nA	
60.00 MΩ		Approx. 10 nA	

Accuracy guarantee condition After zero adjustment has been performed

Capacitance Measurement			
Range	Accuracy	Measurement Current	Open-terminal Voltage
1.000 μF	±1.9% rdg. ±5 dgt.	Approx. 10 nA, 100 nA, 1 μA	DC 2.0 V or less
10.00 μF		Approx. 100 nA, 1 μA, 10 μA	
100.0 μF		Approx. 1 μA, 10 μA, 100 μA	
1.000 mF		Approx. 10 μA, 100 μA, 200 μA	
10.00 mF	±5.0% rdg. ±20 dgt.	Approx. 100 μA, 200 μA	

Frequency	
Range	Accuracy
99.99 Hz	±0.1% rdg. +1 dgt.
999.9 Hz	
9.999 kHz	
99.99 kHz (V AC Only)	

New Standard General Specifications

Durability	
Drop proof	Yes
Operating temperature and humidity*1	-25°C to 65°C
Storage temperature and humidity*2	-30°C to 70°C
Applicable standards	Safety: EN61010, EMC: EN61326; Waterproof and dustproof: IP54*3

*1: 80% RH or less at up to 40°C (non-condensating), linearly decreases from 80% RH at 40°C to 25% RH or less at 65°C (non-condensating)
 *2: 80% RH or less (non-condensating) *3: Do not use in wet conditions.

Dimensions/Weight
87W x 185H x 47D mm (3.43"W x 7.28"H x 1.85"D), 480 g (16.9 oz.) (including batteries)

Safety	
Maximum rated voltage between input terminals and ground	CAT III 1000 V, CAT IV 600 V
Maximum rated voltage between terminals	Between the V and COM terminals: 1000 V DC/AC
Maximum rated current between terminals	Between the A and COM terminals: 10 A DC/10 A AC

Included accessories

TEST LEAD L9300, Instruction Manual, LR6 alkaline battery x 3

Standard DT4252 / DT4253 / DT4255 / DT4256

(Accuracy guaranteed for 1 year)

DC Voltage		
Range	Accuracy	Input Impedance
High precision 600 mV range*1	±0.2% rdg. ±5 dgt.	10.2 MΩ ±1.5%
600.0 mV	±0.3% rdg. ±3 dgt.*2	11.2 MΩ ±2.0%
6.000 V		10.3 MΩ ±2.0%
60.00 V		10.2 MΩ ±1.5%
600.0 V		
1000 V		

*1. DT4252 only
 *2. DT4252, DT4256 only. DT4252, DT4253 : ±5 dgt.

AC Voltage			
Range	Accuracy		Input Impedance
	40 Hz to 500 Hz	500 Hz or more to 1 kHz	
6.000 V	±0.9% rdg. ±3 dgt.	±1.8% rdg. ±3 dgt.	11.2 MΩ ±2.0% // 100 pF or less
60.00 V			10.3 MΩ ±2.0% // 100 pF or less
600.0 V			10.2 MΩ ±1.5% // 100 pF or less
1000 V			

AUTO V (Identification) DT4253, DT4255, DT4256 only			
Range	Accuracy		Input Impedance
	DC, 40 Hz to 500 Hz	500 Hz or more to 1 kHz	
600.0 V	±2.0% rdg. ±3 dgt.	±4.0% rdg. ±3 dgt.	900 kΩ ±20%
Crest factor	3 at up to 4000 counts and reduces linearly to 2 at 6000 counts.		
Accuracy specification range	For AC V, minimum 1% of range; add ±5 dgt. when measuring at or below 5% of range. With the filter ON, the accuracy is not specified at 100 Hz/500 Hz or more.		

DC A Measurement DT4252, DT4253, DT4256 only		
Range	Accuracy	Input Impedance
60.00 μA	±0.8% rdg. ±5 dgt.	1 kΩ ±5%
600.0 μA	±0.8% rdg. ±5 dgt.	1 kΩ ±5%
6.000 mA	±0.8% rdg. ±5 dgt.	15 Ω ±40%
60.00 mA	±0.8% rdg. ±5 dgt.*1	15 Ω ±40%*1
600.0 mA	±0.9% rdg. ±5 dgt.	35 mΩ ±30%
6.000 A	±0.9% rdg. ±3 dgt.*2	35 mΩ ±30%
10.00 A	±0.9% rdg. ±3 dgt.*2	35 mΩ ±30%

●DT4252 ●DT4253 ●DT4256
 *1. DT4256: ±1.8% rdg. ±15 dgt. Input Impedance: 35 mΩ ±30%
 *2. DT4252: ±0.9% rdg. ±5 dgt.

AC A Measurement DT4252, DT4256 only			
Range	Accuracy		Input Impedance
	40 Hz to 500 Hz	500 Hz or more to 1 kHz	
600.0 mA*1	±1.4% rdg. ±5 dgt.	±1.8% rdg. ±5 dgt.	35 mΩ ±30%
6.000 A	±1.4% rdg. ±3 dgt.	±1.8% rdg. ±3 dgt.	
10.00 A			
Crest factor	3 at up to 4000 counts and reduces linearly to 2 at 6000 counts.		
Accuracy specification range	Minimum 1% of range; add ±5 dgt. when measuring 300 counts or less.		

*1. DT4256 only

Electric Charge DT4255, DT4256 only		
Range	Detection voltage range	Detection Target Frequency
Hi	AC 40 V to AC 600 V	50 Hz / 60 Hz
Lo	AC 80 V to AC 600 V	

During voltage detection, a continuous buzzer sounds and the red LED lights up.

Continuity Check			
Range	Accuracy	Measurement Current	Open-terminal Voltage
600.0 Ω	±0.7% rdg. ±5 dgt.	Approx. 200 μA	DC 1.8 V or less
Continuity ON threshold	Approx. 25 Ω or less (continuous buzzer sound, red LED lights)		
Continuity OFF threshold	Approx. 245 Ω or more		

Diode Check			
Range	Accuracy	Measurement Current	Open-terminal Voltage
1.500 V	±0.5% rdg. ±5 dgt.*1	Approx. 0.5 mA	DC 5.0 V or less
Forward threshold	Buzzer sound intermittently at 0.15 V to 1.5 V, the red LED flashes.		

*1. DT4255 : ±0.5% rdg. ±8 dgt.

AC Clamp (AC Current) DT4253, DT4255, DT4256 only	
Range	Accuracy
10.00 A	40 Hz to 1 kHz ±0.9% rdg. ±3 dgt.
20.00 A	
50.0 A	
100.0 A	
200.0 A	
500 A	
1000 A	

The optional 9010-50, 9018-50, or 9132-50 CLAMP ON PROBE is used. Accuracy does not include the error of the clamp-on probe.

Crest factor	3 or less
Accuracy specification range	Minimum 1% of range; add ±5 dgt. when measuring at or below 5% of range.

Resistance Measurement			
Range	Accuracy	Measurement Current	Open-terminal Voltage
600.0 Ω	±0.7% rdg. ±3 dgt.*1	Approx. 200 μA	DC 1.8 V or less
6.000 kΩ		Approx. 100 μA	
60.00 kΩ		Approx. 10 μA	
600.0 kΩ		Approx. 1 μA	
6.000 MΩ	±0.9% rdg. ±3 dgt.*1	Approx. 100 nA	
60.00 MΩ	±1.5% rdg. ±3 dgt.*1	Approx. 10 nA	

Accuracy guarantee condition After zero adjustment has been performed.

*1. DT4252, DT4253 : ±5 dgt.

Capacitance Measurement			
Range	Accuracy	Measurement Current	Open-terminal Voltage
1.000 μF	±1.9% rdg. ±5 dgt.	Approx. 10 nA, 100 nA, 1 μA	DC 1.8 V or less
10.00 μF		Approx. 100 nA, 1 μA, 10 μA	
100.0 μF		Approx. 1 μA, 10 μA, 100 μA	
1.000 mF		Approx. 10 μA, 100 μA, 200 μA	
10.00 mF	±5.0% rdg. ±20 dgt.	Approx. 100 μA, 200 μA	

Temperature		DT4253 only
Thermocouple Type	Range	Accuracy
K	-40.0°C to 400.0°C (-40.0°F to 752.0°F)	±0.5% rdg. ±2°C

The optional K Thermocouple DT4910 is used. Accuracy does not include the error of the K thermocouple.

Frequency		
Range	Accuracy	
99.99 Hz	±0.1% rdg. +1 dgt.	
999.9 Hz		
9.999 kHz		
99.99 kHz (V AC only)		

Standard General Specifications

Durability		
Drop proof	Yes	
Operating temperature and humidity ¹	-25°C to 65°C (DT4254, DT4255, DT4256) -10°C to 50°C (DT4252, DT4253)	
Storage temperature and humidity ²	-30°C to 70°C (DT4254, DT4255, DT4256) -30°C to 60°C (DT4252, DT4253)	
Applicable standards	IP40 (When operating), IP42 (While in storage) ³	

- *1. -10°C to 50°C(14°F to 122°F), Up to 40°C(104°F): at 80% RH or less(non-condensating), 40°C to 45°C (104°F to 113°F): at 60% RH or less(non-condensating), 45°C to 55°C (113°F to 131°F): at 50% RH or less (non-condensating)
- *1. Up to 40°C(104°F): at 80% RH or less(non-condensating), 40°C to 65°C (104°F to 149°F): reduces linearly 80% RH to 25% RH or less
- *2. 80% RH or less (non-condensating)
- *3. Do not use in wet conditions. Excludes measuring terminals

Dimensions/Weight

84W × 174H × 52D mm (3.31"W × 6.85"H × 2.05"D),
390 g (13.8 oz.) (including batteries and holster)

Safety		
Maximum rated voltage between input terminals and ground	CAT III 1000 V, CAT IV 600 V	
Maximum rated voltage between terminals	Between the V and COM terminals: DC 1000 V, AC 1000 V	
Maximum rated current between terminals	Between the A and COM terminals: DC 10 A / AC 10 A (DT4252, DT4256) Between the μ A, mA and COM terminals: DC 60 mA (DT4253 only)	

Your instrument can be used to measure voltages in excess of 1000 V DC if and only if both of the following conditions are satisfied:

1. The circuit under measurement is isolated from the commercial power grid.
2. The circuit under measurement is isolated from ground.

Included accessories

TEST LEAD L9207-10, Instruction Manual, LR03 Alkaline battery × 4,
Holster (attached to the instrument, with a test lead holder)

Pocket DT4221 / DT4222 / DT4223 / DT4224

(Accuracy guaranteed for 1 year)

DC Voltage		
Range	Accuracy	Input Impedance
600.0 mV	±0.5% rdg. ±5 dgt.	11.2 MΩ ±2.0%
6.000 V		
60.00 V		
600.0 V		

AC Voltage			
Range	Accuracy		Input Impedance
	40 Hz to 500 Hz	500 Hz or more to 1 kHz	
6.000 V	±1.0% rdg. ±3 dgt.	±2.5% rdg. ±3 dgt.	11.2 MΩ ±2.0% // 100 pF or less
60.00 V		±2.0% rdg. ±3 dgt.	10.3 MΩ ±2.0% // 100 pF or less
600.0 V			10.2 MΩ ±1.5% // 100 pF or less
Crest factor		3 at up to 4000 counts and reduces linearly to 2 at 6000 counts.	
Accuracy specification range		For AC V, minimum 1% of range; add ±5 dgt. when measuring at or below 5% of range. With the filter ON, the accuracy is not specified in 100/500 Hz or more.	

AUTO V (Identification) DT4221, DT4223 only			
Range	Accuracy		Input Impedance
	DC, 40 Hz to 500 Hz	500 Hz or more to 1 kHz	
600.0 V	±2.0% rdg. ±3 dgt.	±4.0% rdg. ±3 dgt.	900 kΩ ±20%
Crest factor		3 at up to 4000 counts and reduces linearly to 2 at 6000 counts.	
Accuracy specification range		For AC V, minimum 1% of range; add ±5 dgt. when measuring at or below 5% of range. With the filter ON, the accuracy is not specified in 100/500 Hz or more.	

Electric Charge DT4221, DT4223 only	
Detection Voltage Range	Detection Target Frequency
AC 80 V to AC 600 V	50 Hz / 60 Hz

During voltage detection, a continuous buzzer sounds.

Continuity Check			
Range	Accuracy	Measurement Current	Open-terminal Voltage
600.0 Ω	±1.0% rdg. ±5 dgt.	Approx. 200 μ A	DC 1.8 V or less (DT4221, DT4222) DC 2.0 V or less (DT4223, DT4224)
Continuity ON threshold		Approx. 25 Ω or less (continuous buzzer sound)	
Continuity OFF threshold		Approx. 245 Ω or more	

Diode Check DT4222, DT4224 only			
Range	Accuracy	Measurement Current	Open-terminal Voltage
1.500 V	±0.9% rdg. ±5 dgt.	Approx. 0.5 mA (DT4222) Approx. 0.2 mA (DT4224)	DC 2.5 V or less

Resistance Measurement DT4222, DT4223, DT4224 only			
Range	Accuracy	Measurement Current	Open-terminal Voltage
600.0 Ω	±0.9% rdg. ±5 dgt.	Approx. 200 μ A	DC 1.8 V or less (DT4222)
6.000 kΩ		Approx. 100 μ A	
60.00 kΩ		Approx. 10 μ A	
600.0 kΩ		Approx. 1 μ A	DC 2.0 V or less (DT4223, DT4224)
6.000 MΩ		Approx. 100 nA	
60.00 MΩ		Approx. 10 nA	
Accuracy guarantee condition		After zero adjustment has been performed.	

Capacitance Measurement DT4222, DT4224 only			
Range	Accuracy	Measurement Current	Open-terminal Voltage
1.000 μ F	±1.9% rdg. ±5 dgt.	Approx. 10 nA, 100 nA, 1 μ A	DC 1.8 V or less (DT4222)
10.00 μ F		Approx. 100 nA, 1 μ A, 10 μ A	
100.0 μ F		Approx. 1 μ A, 10 μ A, 100 μ A	DC 2.0 V or less (DT4223, DT4224)
1.000 mF		Approx. 10 μ A, 100 μ A, 200 μ A	
10.00 mF	±5.0% rdg. ±20 dgt.	Approx. 100 μ A, 200 μ A	

Frequency		
Range	Accuracy	
99.99 Hz	±0.1% rdg. +2 dgt.	
999.9 Hz		
9.999 kHz		

Pocket General Specifications

Durability	
Drop proof	Yes
Operating temperature and humidity*1	-10°C to 50°C (DT4221, DT4222) -10°C to 65°C (DT4223, DT4224)
Storage temperature and humidity*2	-30°C to 60°C (DT4221, DT4222) -30°C to 70°C (DT4223, DT4224)
Applicable standards	IP40 (When operating), IP42 (While in storage)*3

*1. -10°C to 50°C(14°F to 122°F), Up to 40°C(104°F): at 80% RH or less (non-condensating),
40°C to 45°C (104°F to 113°F): at 60% RH or less (non-condensating),
45°C to 65°C (113°F to 122°F): at 50% RH or less (non-condensating)

*2. 80% RH or less (non-condensating)

*3. Do not use in wet conditions. Excludes measuring terminals.

Dimensions/Weight
72W x 149H x 38D mm (2.83"W x 5.87"H x 1.50"D), 190 g (6.7 oz.) (including batteries and holster)

Safety	
Maximum rated voltage between input terminals and ground	CAT III 600 V, CAT IV 300 V
Maximum rated voltage between terminals	Between the V and COM terminals: 600 V DC/AC

Included accessories

TEST LEAD DT4911, Instruction Manual, LR03 Alkaline battery x 1, Holster (attached to the instrument, with a test lead holder)

Models



High-end models		
Model no. (order code)	DT4281	DT4282



New standard model		
Model no. (order code)	DT4261	DT4261-90*

*Z3210 set product



Standard models				
Model no. (order code)	DT4252	DT4253	DT4255	DT4256



Pocket models				
Model no. (order code)	DT4221	DT4222	DT4223	DT4224

Accessories / Options

L9300 / L9207-10 / DT4911 Options (Included accessories)

DT4261 (Included accessory)

TEST LEAD L9300
Cable length 95 cm (3.12 ft)
Integrated cap and protective finger guard

- Exposed tip metal pin: short
CAT III 1000 V, CAT IV 600 V
- Exposed tip metal pin: long

DT4280/DT4250 Series (Included accessory)

TEST LEAD L9207-10
Cable length 90 cm (2.95 ft)
with one each red and black caps

- with cap
CAT III 1000 V, CAT IV 600 V
- without cap
CAT II 1000 V

DT4220 Series (Included accessory)

TEST LEAD DT4911
Cable length 54 cm (1.77 ft)
with one each red and black caps

- with cap
CAT IV 300 V, CAT III 600 V
- without cap
CAT II 600 V

The L4933 and L4934 can be attached to the tip of the L9300, L9207-10 and DT4911. When attaching them, make sure they are in the measuring category-II-state (with the caps removed for the L9207-10 and DT4911).

CONTACT PIN SET L4933
DC 70 V
AC 33 V

SMALL ALLIGATOR CLIP SET L4934
CAT II 600 V
CAT III 300 V

Option for DT4261: DC HIGH VOLTAGE PROBE P2000

DC HIGH VOLTAGE PROBE P2000
Cable length 150 cm (4.92 ft)*
*Probe side
CAT III 2000 V

P2000 Specifications	
Maximum input voltage	DC 2000 V (max. rated voltage between INPUT H-INPUT L)
Maximum rated voltage to earth	2000 V (Measurement Category III) anticipated transient overvoltage 15,000 V 1000 V (Measurement Category IV) anticipated transient overvoltage 12,000 V
Input resistance	20 MΩ ± 1.0% (between INPUT H - INPUT L)
Output ratio	Depends on the input impedance of the connected device (example: 1/10 when a device with an input impedance of 10 MΩ is connected)
Overload protection	DC/AC 2200 V 1 minutes (between INPUT H - INPUT L) DC/AC 600 V 1 minutes (between OUTPUT H - OUTPUT L)
Secondary terminal	4 mm banana terminal

Operating environment	Indoor use, pollution degree 2, altitude up to 2000 m
Operating temperature and humidity range	Temperature: -25°C to 65°C (-13°F to 149°F) Humidity: -25°C to 40°C (-13°F to 104°F), up to 80% RH (non-condensing) 40°C to 65°C (104°F to 149°F), (the operation humidity limit falls linearly from 40°C 80% RH to 65°C 25% RH, given that there is no condensation)
Storage temperature and humidity range	-30°C to 70°C (-22°F to 158°F) 90% RH or less (non-condensing)
Applicable standards	Safety EN 61010
Product warranty period	3 years (probe body and cable part are not covered by warranty)
Included accessories	L4943 connection cable*, Strap belt, Strap buckles x 2, CO205 carrying case, "Instruction Manual", "Usage Precautions"

*L4930, L4931 can be used to extend the cable

L4930 Options

Compatible DMMs: DT4261, DT4250 Series, DT4280 Series



CONNECTION CABLE L4930
Length : 1.2 m (3.937 ft)

Probe tips (at right) can be used on L4930 connection cables.



22 mm(0.87 in)
φ3.7 mm(0.15 in)

with one each red and black caps
CAT III 600 V (with cap)
CAT II 600 V (without cap)
TEST PIN SET L4938



CAT III 1000 V
CAT IV 600 V
ALLIGATOR CLIP SET L4935



30 mm
(1.18 in)
CAT III 600 V
BUS BAR CLIP SET L4936



Magnet
φ6 mm(0.24 in)
CAT III 1000 V
MAGNETIC ADAPTER SET L4937



22 mm(0.87 in)
φ3.7 mm(0.15 in)
48 mm(1.89 in)
φ2.6 mm(0.15 in)
CAT III 600 V
BREAKER PIN L4939



CAT III 1000 V
CAT IV 600 V
with one each red and black caps
TEST PIN SET L4932





CAT II 1000 V
GRABBER CLIP L9243



CAT III 1000 V
CAT IV 600 V
Length : 1.5 m (4.9212 ft)
With coupling connectors
EXTENSION CABLE SET L4931

AC CLAMP ON PROBES for DT4281, DT4261, DT4253, DT4255, DT4256 (Adapter 9704 required for connection)

Product appearance	 CAT III 600 V	 CAT III 600 V	 CAT III 600 V
Model number	9010-50	9018-50	9132-50
Rated current	AC 10 A, 20 A, 50 A, 100 A, 200 A, 500 A	AC 10 A, 20 A, 50 A, 100 A, 200 A, 500 A	AC 20 A, 50 A, 100 A, 200 A, 500 A, 1000 A
Amplitude accuracy (45 Hz to 66 Hz)	±2% rdg. ±1% f.s.	±1.5% rdg. ±0.1% f.s.	±3% rdg. ±0.2% f.s.
Frequency characteristics	40 Hz to 1 kHz:±6% rdg.	40 Hz to 3 kHz:±1% rdg.	40 Hz to 1 kHz:±1% rdg.
Output rate	AC 0.2 V f.s. (For each range)		
Max. circuit voltage	AC 600 V (50/60 Hz)		
Diameter	φ46 mm (1.81 in) or less		φ55 mm (2.17 in) or less, 80 × 20 mm (3.15 × 0.79 in)
Dimensions, mass	78W × 188H × 35D mm (3.07"W × 7.40"H × 1.38"D), 420 g (14.8 oz.), cord length 3 m (9.84 ft)		100W × 224H × 35D mm (3.94"W × 8.82"H × 1.38"D), 600 g (21.1 oz.), cord length 3 m (9.84 ft)

Adapter Model 9704 is required to connect AC CLAMP ON PROBES 9010-50, 9018-50 and 9132-50 to the DT4281, DT4261, DT4253, DT4255, DT4256.



CONVERSION ADAPTER 9704

Other options



THERMOCOUPLES (K) DT4910

- Thermal junction form: exposed weld
- Sensor length: approx. 800 mm
- Measurement temperature range: -40 to 260°C
- Allowable tolerance: ±2.5°C



COMMUNICATION PACKAGE (USB) DT4900-01

- Communication cable
 - Communication adapter
 - PC software
 - Instruction manual
- OS: Windows 10



MAGNETIC STRAP Z5004 **MAGNETIC STRAP Z5020**



WIRELESS ADAPTER Z3210

For DT4261
Enables Bluetooth® communication



CARRYING CASE C0200
DT4220 Series



CARRYING CASE C0202
DT4250, DT4280 Series, DT4261



CARRYING CASE C0201
DT4250 Series



CARRYING CASE C0207

Bag type for use with all field products

Downloading GENNECT Cross

Data can be downloaded to tablets and smartphones using Hioki's dedicated apps available from the Google Play or App Store. Search for "HIOKI" and download the "GENNECT Cross" app.



*Android, Google Play and the Google Play logo are trademarks of Google Inc.
 *iOS is a registered trademark of Cisco Technology, Inc. and/or its affiliates in the United States and certain other countries.
 *iPhone, iPad, iPad mini, iPad Pro and iPod touch are trademarks of Apple Inc.
 *Apple and the Apple logo are trademarks of Apple Inc. App Store is a service mark of Apple Inc.
 *Microsoft, Windows, Windows Vista, and Excel are either registered trademarks or trademarks of Microsoft Corporation in the United States and/or other countries.
 *Company names and product names appearing in this catalog are trademarks or registered trademarks of various companies.
 *The Bluetooth® word mark and logos are registered trademarks owned by Bluetooth SIG, Inc. and any use of such marks by HIOKI E.E. CORPORATION is under license.
 *For the latest information about countries and regions where wireless operation is currently supported, please visit the Hioki website.

Note: Company names and product names appearing in this brochure are trademarks or registered trademarks of various companies.

HIOKI
HIOKI E. E. CORPORATION

HEADQUARTERS
81 Koizumi,
Ueda, Nagano 386-1192 Japan
<https://www.hioki.com/>



Scan for all regional contact information